

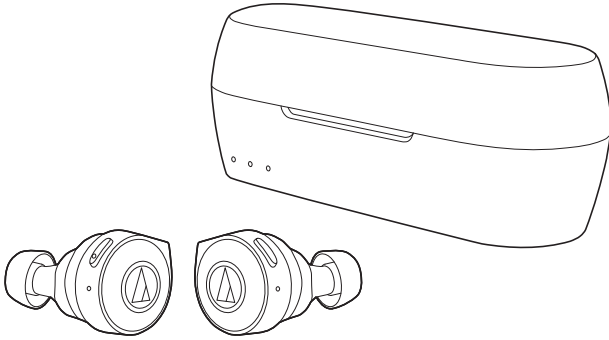

ATH-CKS5TW

User Manual
Wireless Headphones



Introduction

Thank you for purchasing this Audio-Technica product.

Before using the product, please read through the Quick Start Guide and Caution Guide, as well as this user manual when necessary, to ensure that you use the product correctly.

Safety precautions

Although this product was designed to be used safely, failing to use it correctly may result in an accident. To ensure safety, observe all warnings and cautions while using the product.

Cautions for the headphones

- Do not use the product near medical equipment. Radio waves may affect cardiac pacemakers and medical electronic equipment. Do not use the product inside medical facilities.
- When using the product in aircraft, follow airline instructions.
- Do not use the product near automatic control devices such as automatic doors and fire alarms. Radio waves may affect electronic equipment and cause accidents due to malfunction.
- Do not disassemble, modify or attempt to repair the product to avoid electric shock, malfunction or fire.
- Do not subject the product to strong impact to avoid electric shock, malfunction or fire.
- Do not handle the product with wet hands to avoid electric shock or injury.
- Disconnect the product from a device if the product begins to malfunction, producing smoke, odor, heat, unwanted noise or showing other signs of damage. In such a case, contact your local Audio-Technica dealer.
- Do not allow the product to get wet to avoid electric shock or malfunction.
- Do not put foreign matter such as combustible materials, metal, or liquid in the product.
- Do not cover the product with a cloth to avoid fire or injury by overheating.
- Follow applicable laws regarding mobile phone and headphone use if using headphones while driving.
- Do not use the product in places where the inability to hear ambient sound presents a serious risk (such as at railroad crossings, train stations, and construction sites).
- The product effectively shields external sound, so you may not hear sound around you clearly while wearing the product. Adjust the volume to a level where you can still hear background sound and monitor the area around you while listening to music.
- Store the product out of the reach of small children.
- To prevent damage to your hearing, do not raise the volume too high. Listening to loud sound for an extended period may cause temporary or permanent hearing loss.
- Discontinue use if skin irritation results from direct contact with the product.
- If you begin to feel unwell while using the product, discontinue use immediately.
- When removing the product from your ears, check to make sure the eartips are still attached to the main unit. If the eartips become lodged in your ears and you are unable to remove them, consult a physician at once.
- If you develop an itch from wearing the product, discontinue use.

Safety precautions

Cautions for charging case

- Do not disassemble, modify or attempt to repair the product to avoid electric shock, malfunction or fire.
- Do not subject the product to strong impact to avoid electric shock, malfunction or fire.
- Do not handle the product with wet hands to avoid electric shock or injury.
- Disconnect the product from a device if the product begins to malfunction, producing smoke, odor, heat, unwanted noise or showing other signs of damage. In such a case, contact your local Audio-Technica dealer.
- Do not allow the product to get wet to avoid electric shock or malfunction.
- Do not put foreign matter such as combustible materials, metal, or liquid in the product.
- Do not cover the product with a cloth to avoid fire or injury by overheating.
- When charging, make sure to use the included USB charging cable.
- Do not charge with devices that have quick-charge functionality (with a voltage of 5 V or more). Doing so may cause the product to malfunction.
- Do not store the product in direct sunlight, near heating devices, or in hot, humid, or dusty places because such storage could cause malfunction or defect.
- Do not put it close to fire because that could cause deformation or malfunction.
- Do not use benzine, paint thinners and electrical contact cleaner, etc. because use of such material could cause deformation or malfunction.

Safety precautions

Cautions for rechargeable battery

The headphones are equipped with a rechargeable battery (lithium ion battery).

The charging case is equipped with a rechargeable battery (lithium polymer battery).

- If battery fluid gets into eyes, do not rub them. Rinse thoroughly with clean water such as tap water and consult a doctor immediately.
- If battery fluid leaks, do not touch fluid with bare hands. If fluid remains inside the product, it may cause malfunction. If battery fluid leaks, contact your local Audio-Technica dealer.
 - If fluid gets in your mouth, gargle thoroughly with clean water such as tap water and consult a doctor immediately.
 - If your skin or clothing comes in contact with fluid, immediately wash the affected skin or clothing with water. If you experience skin irritation, consult a doctor.
- To avoid leakage, generation of heat or explosion:
 - Never heat, disassemble or modify the battery, nor dispose of it in a fire.
 - Do not attempt to pierce with a nail, hit with a hammer or step on the battery.
 - Do not drop the product or subject it to strong impact.
 - Do not get the battery wet.
- Do not use, leave or store the battery in the following places:
 - Area exposed to direct sunlight or high temperatures and humidity
 - Inside of a car under the blazing sun
 - Near heat sources such as heat registers
- Charge only with the included USB cable to avoid malfunction or fire.
- The internal rechargeable battery of this product cannot be replaced by the user. The battery may have reached the end of its service life if the usage time becomes significantly shorter even after the battery has been fully charged. If this is the case, the battery needs to be repaired. Contact your local Audio-Technica dealer for repair details.
- When the product is disposed of, the built-in rechargeable battery needs to be discarded properly. Contact your local Audio-Technica dealer to learn how to properly dispose of the battery.

For customers in the USA

FCC Notice

Warning

This device complies with Part 15 of the FCC Rules.

Operation is subject to the following two conditions: (1) This device may not cause harmful interference, and (2) this device must accept any interference received, including interference that may cause undesired operation.

Caution

You are cautioned that any changes or modifications not expressly approved in this manual could void your authority to operate this equipment.

Note: This equipment has been tested and found to comply with the limits for a Class B digital device, pursuant to part 15 of the FCC Rules. These limits are designed to provide reasonable protection against harmful interference in a residential installation. This equipment generates, uses and can radiate radio frequency energy and, if not installed and used in accordance with the instructions, may cause harmful interference to radio communications. However, there is no guarantee that interference will not occur in a particular installation. If this equipment does cause harmful interference to radio or television reception, which can be determined by turning the equipment off and on, the user is encouraged to try to correct the interference by one or more of the following measures:

- Reorient or relocate the receiving antenna.
- Increase the separation between the equipment and receiver.
- Connect the equipment to an outlet on a circuit different from that to which the receiver is connected.
- Consult the dealer or an experienced radio/TV technician for help.

RF Exposure Statement

This transmitter must not be co-located or operated in conjunction with any other antenna or transmitter used in other systems. This device complies with FCC radiation exposure limits set forth for an uncontrolled environment and meets the FCC radio frequency (RF) Exposure Guidelines. This equipment has very low levels of RF energy that is deemed to comply without testing of specific absorption rate (SAR).

For customers in Canada

IC statement

CAN ICES-3 (B)/NMB-3(B)

This device complies with Industry Canada's licence-exempt RSSs. Operation is subject to the following two conditions:

(1) This device may not cause interference; and (2) This device must accept any interference, including interference that may cause undesired operation of the device.

Under Industry Canada regulations, this radio transmitter may only operate using an antenna of a type and maximum (or lesser) gain approved for the transmitter by Industry Canada. To reduce potential radio interference to other users, the antenna type and its gain should be so chosen that the equivalent isotropically radiated power (e.i.r.p.) is not more than that necessary for successful communication.

This device complies with RSS-102 radiation exposure limits set forth for an uncontrolled environment.

Notes on use

- Be sure to read the connected device's user manual before use.
- Audio-Technica will not be liable in any way for any loss of data in the unlikely event that such losses should occur while using the product.
- On public transportation or in other public places, keep the volume low so as not to disturb other people.
- Minimize the volume on your device before reproducing music.
- When using the product in a dry environment, you may feel a tingling sensation in your ears. This is caused by static electricity accumulated on your body, not by product malfunction.
- Do not subject the product to strong impact.
- Do not store the product in direct sunlight, near heating devices, or in hot, humid, or dusty places.
- When the product is used for a long time, the product may become discolored due to ultraviolet light (especially direct sunlight) and wear.
- If the charging case is placed in a bag while the USB charging cable is still connected, the USB charging cable may become caught, severed, or broken.
- Make sure to hold the plug when connecting and disconnecting the USB charging cable. The USB charging cable may become severed or an accident may occur if you pull on the cable itself.
- When you are not using the USB charging cable, disconnect it from the charging case.
- When you are not using the product, store it in the included charging case.
- If you use eartips other than those included, the headphones may not fit into the charging case, or may not charge. Be sure to use the included eartips.
- This product can be used to talk on the phone only when using a mobile telephone network. Support for telephony apps that use a mobile data network is not guaranteed.
- If you use the product near an electronic device or transmitter (such as a mobile phone), unwanted noise may be heard. In this case, move the product away from the electronic device or transmitter.
- If you use the product near a TV or radio antenna, noise may be seen or heard in the television or radio signal. In this case, move the product away from the TV or radio antenna.
- To protect the built-in rechargeable battery, charge it at least once every 6 months. If too much time passes between charges, the life of the rechargeable battery may be reduced, or the rechargeable battery may no longer be able to be charged.

About water-resistant (drip-proof) performance

- The water-resistant (drip-proof) specification of this product applies only to the headphones, not the charging case.
- The water-resistant (drip-proof) performance is designed to protect the headphones if they get wet from rain, etc. (equivalent to IPX2). JIS/IEC protection grade IPX2 means that the headphones are protected against water droplets falling from above at a 15-degree angle. The headphones cannot be used in hot and humid places, such as bathrooms.
- The headphones are not waterproof. Submerging them in water may cause damage.

For a more comfortable Bluetooth® communication experience

The effective communication range of this product varies depending on obstructions and radio wave conditions. For a more enjoyable experience, please use the product as close as possible to the Bluetooth device. To minimize noise and sound disruptions, avoid placing your body or other obstacles between the product's antenna (R side) and the Bluetooth device.

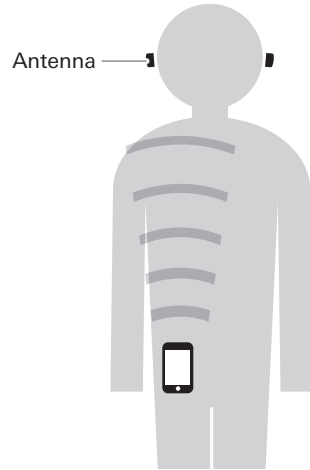

Part names and functions

Headphones

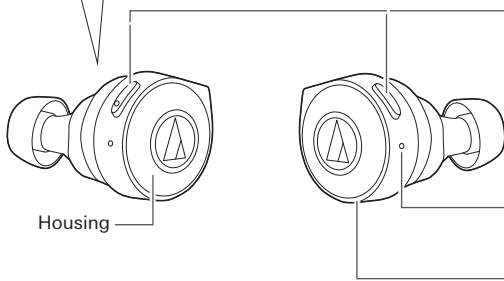
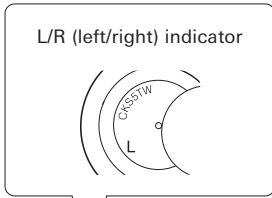

Multifunction buttons
Use to turn the power supply ON/OFF, play/pause music, and answer/end phone calls.
Also use to adjust the volume (+/-).

The L-side button has a protrusion for distinguishing between the left and right.

Indicator lamp
Displays the operating status and battery level of the headphones.

Microphone (R side only)

Charging case

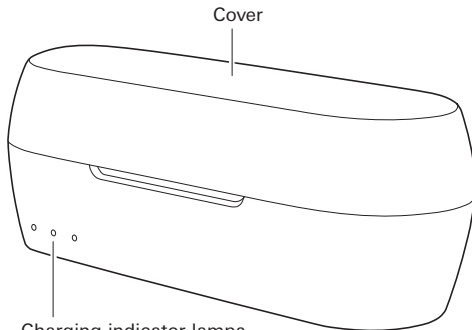

Charging indicator lamps
Displays the battery level of the charging case.

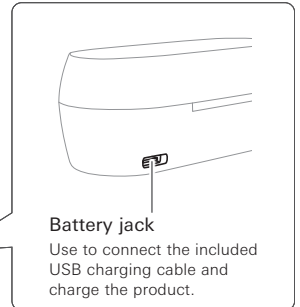

Battery jack
Use to connect the included USB charging cable and charge the product.

■ Accessories

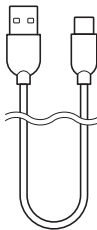

- USB charging cable (30 cm (12")), USB Type-A / USB Type-C™)



- Eartips* (XS, S, M, L)



- Silicone rings

* At the time of purchase, the M-size eartips are attached to the headphones.

Charging the battery

Charging the headphones and charging case

- Fully charge the battery when using for the first time.
 - If the rechargeable battery power is running low, the product will beep through the headphones, and the indicator lamps of the headphones will flash in red. In this case, charge the battery.
 - It takes about 2 hours maximum to fully charge the headphones, about 3.5 hours maximum to fully charge the charging case. (This time may vary depending on usage conditions.)
1. Connect the included USB charging cable (USB Type-C side) to the battery jack of the charging case.
 - The included USB charging cable is designed for exclusive use with the product. Do not use any other USB charging cable.
 - When inserting the USB charging cable into the USB port or battery jack, insert it directly (horizontally).
 2. Connect the included USB charging cable (USB Type-A side) to the computer to start charging.

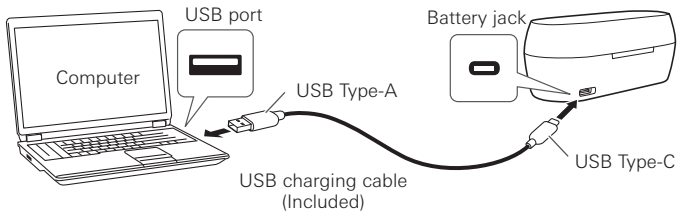



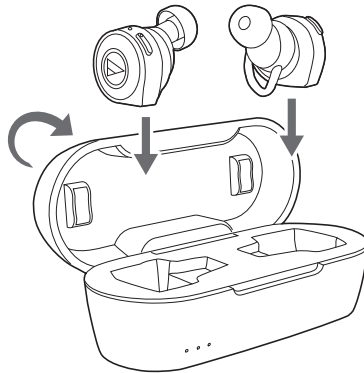





3. After placing the headphones in the charging case, close the cover.



Charging the battery

- During charging, the 3 charging indicator lamps light and flash as follows to indicate the battery level of the charging case (it may take several seconds for the indicator lamps to light).

Battery (charging) status of the charging case	Charging indicator lamps ○White ●Off	
	Lamp display	Light pattern
		Only left lamp flashing
		Only center lamp flashing
		Only right lamp flashing
 (Fully charged)		Lit in white for 10 seconds, and then turns off

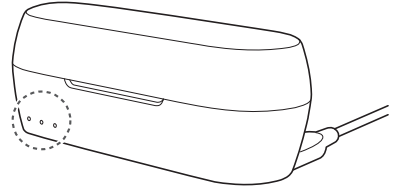

4. When charging is complete, disconnect the USB charging cable (USB Type-A side) from the computer.
5. Disconnect the USB charging cable (USB Type-C side) from the battery jack on the charging case.

- When charging, make sure to use the included USB charging cable. The product may not charge with cables other than the included USB charging cable.

Charging the battery

Charging headphones without the charging cable

A rechargeable battery is built into the charging case. If you have charged the charging case, you can charge the headphones without using the USB charging cable.

- If the rechargeable battery power is running low, the product will beep through the headphones, and the indicator lamps of the headphones will flash in red.
1. Place the headphones in the charging case.
 - When charging, the indicator lamps of the headphones light as follows (it may take several seconds for the indicator lamps to light).
Lit in white : Charging
Off: Charging complete
 2. Close the charging case cover.

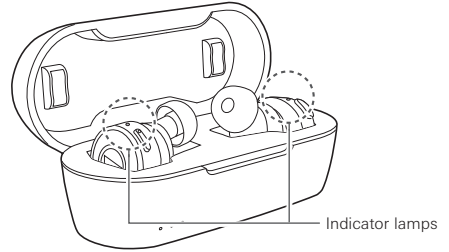

Checking the battery level of the charging case

1. When opening/closing the cover of the charging case, the 3 charging indicator lamps light as follows to indicate the battery level of the charging case.

Battery (charging) status of the charging case	Charging indicator lamps ○White ●Off	
	Lamp display	Light pattern
	○ ● ●	Only left lamp lit
	○ ○ ●	Left and center lamps lit
	○ ○ ○	All lamps lit
 (Charging required)	○ ● ●	Only left lamp flashing quickly (twice in a row)

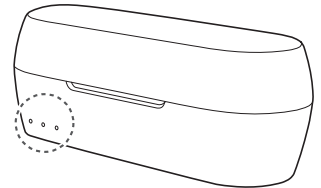

Connecting via Bluetooth

To connect the product to a Bluetooth device, the product needs to pair (register) with the device.

Pairing a Bluetooth device

- Read the user manual for the Bluetooth device.
 - Place the Bluetooth device within 1 m (3.3') of the product to perform pairing correctly.
 - To confirm the progress of the pairing process, wear the product while performing this procedure and listen for the confirmation tone.
1. Remove the headphones (L (left) and R (right)) from the charging case.
 - The indicator lamps will flash in white.
 2. Use your Bluetooth device to begin the pairing process and search for the product. When your Bluetooth device finds the product, "ATH-CK55TW" will be displayed on the device.
 - For information about using your Bluetooth device, refer to the device's user manual.
 - This product may be displayed as "ATH-CK55TW", "BLE_ATH-CK55TW", or both. If both are displayed, select "ATH-CK55TW". If only one is displayed, select that one.
 3. Select "ATH-CK55TW" to pair the product and your Bluetooth device.
 - Some devices may ask for a passkey. In this case, enter "0000". The passkey may also be called a passcode, PIN code, PIN number, or password.
 - The product sounds a confirmation tone when pairing is complete.



About pairing

When connecting a new Bluetooth device, you need to pair it with the product. Once the Bluetooth device and the product are paired, you do not need to pair them again. The product supports multipairing, in which a connection history is saved.

However, in the following cases you will need to pair again even if the Bluetooth device was paired once:

- If the product is deleted from the Bluetooth device's connection history.
 - If the product is sent out for repair.
-
- When switching to a Bluetooth device, you may not be able to pair because the previously connected Bluetooth device cannot be disconnected. In such cases, place the headphones into the charging case (with battery level remaining for the case) and press and hold (about 6 seconds) the multifunction button on the R (right) side. The indicator lamp lights in red. After lighting in red, the product will switch to the "searching for devices" state and you will be able to pair with your desired Bluetooth device.

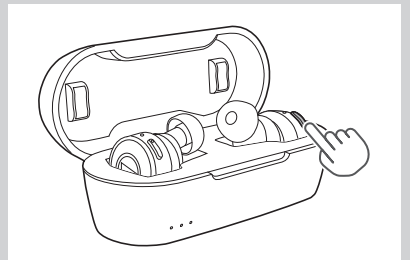





Using the product

The product can use Bluetooth wireless technology to connect to your device and play music, receive phone calls, etc. Use the product for whichever of these purposes suits your needs.

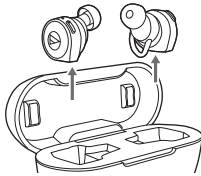
Note that Audio-Technica cannot guarantee the operation of displays, such as the battery level display, or applications via Bluetooth devices.

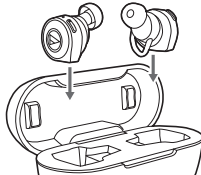
Power supply ON/OFF

Power supply	Operation		Indicator lamps
ON* ¹	Remove from the charging case and power turns on automatically.		Lights in white, then flashes in white* ² * ³
	Press and hold (for about 2 seconds) the multifunction buttons to turn the power on manually.		
OFF* ¹	Place in the charging case and power turns off automatically.		Lights in white, then turns off* ³
	Press and hold (for about 4 seconds) the multifunction buttons to turn the power off manually.* ⁴		

*¹ If you are wearing the product, you will hear a beep to indicate when the product has turned on and off.

*² It may take several seconds for the indicator lamp to light.

*³ For details, please refer to "Indicator lamps on the headphones" (p.15).

*⁴ When you turn off the R (right) side, the L (left) side also turns off automatically.

Using the product

Wearing the product

Insert the side of the product marked "L" (LEFT) into the left ear, and the side marked "R" (RIGHT) into the right ear as shown in the figure.

- When worn on the ear while slightly bending the 3D loop support included with the headphones, the fit is stable.

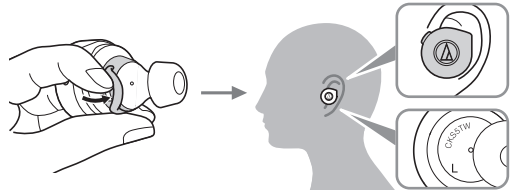

Attaching/Removing the silicone rings

The 3D loop supports are attached to the headphones to provide better fit and stability. Use the included silicone rings as needed.

1. Remove the 3D loop supports that come attached to the headphones.

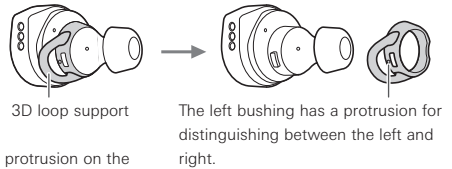

2. Attach the silicone rings to the headphones.

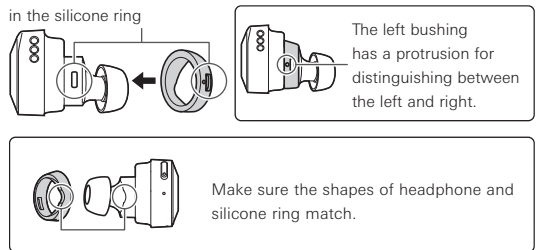

3. Wear the headphones.

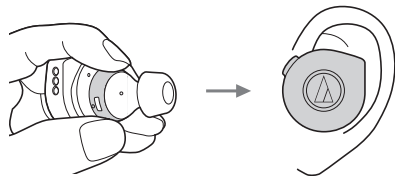

- When reattaching the 3D loop supports, make sure to attach them correctly. If you attach them incorrectly, they will not enter the charging case.

Using the product

Listening to music

- To connect for the first time, pair the product and your device via Bluetooth wireless technology. If you have already paired the product and your Bluetooth device, turn on the Bluetooth device's Bluetooth connection before turning on the product.
- Use your Bluetooth device to start playback, referring to the device's user manual as necessary.

Multifunction button (R (right) side)

Press	Play/pause	Plays or pauses music. *
Press (twice)	Skip forward	Plays the next track. *
Press (three times)	Skip back	Plays the previous track. *

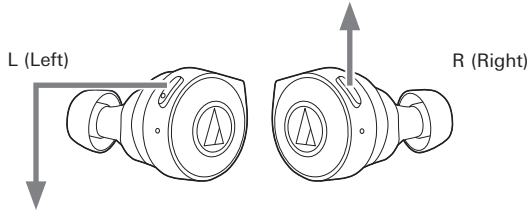

Multifunction button (L (left) side)

Press	Volume up	Increases the volume by 1 level.
Press (twice)	Volume down	Decreases the volume by 1 level.

* Some controls may not be available for music playback on some smartphones.

- The volume control of some devices may not work well with the product.

Using the product

Talking on the phone

- If your Bluetooth device supports telephone features, you can use the microphone built into the product to talk on the phone.
- When your Bluetooth device receives a phone call, a ring tone will be heard through the headphones.
- If a call is received while you are listening to music, music playback is paused. When you finish the call, music playback resumes. *1

When	Function	Operation
Receiving a call	Press the multifunction button on the R (right) side headphone.	Answers the call.
	Press and hold (about 3 seconds) the multifunction button on the R (right) side headphone.	Rejects the call.
Talking*2	Press the multifunction button on the R (right) side headphone.	Ends the call.
	Press and hold (about 3 seconds) the multifunction button on the R (right) side headphone. *3	Each time you press and hold the button (about 3 seconds), you switch the call to your mobile phone or to the product. *3

*1 Depending on your Bluetooth device, music playback may not resume.

*2 Adjust the volume of a call on the Bluetooth device.

*3 When you hear a confirmation tone, release your finger from the multifunction button.

- The phone call controls explained above may not be available on some smartphones.

Auto power off function

The product automatically turns off after 5 minutes of not being connected to a device.

Reset function

If the product does not work, or other malfunctions occur, place the headphones in the charging case while referring to "Charging the battery" (p.7) for information on inserting the USB charging cable to provide power, and then do a reset.

Disconnecting and then reconnecting the USB charging cable will reset the product and should resolve any problem you are experiencing. If the problem persists, contact your local Audio-Technica dealer. Resetting does not change any of your settings (pairing information, volume setting, etc.).

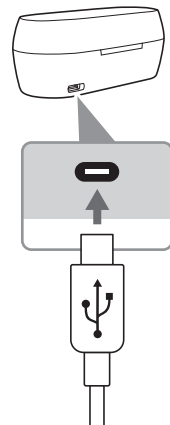

Using the product

App for smartphones

You can use Audio-Technica's app for smartphones for more convenient use of the product.



CONNECT App
iOS, Android



<https://app.at-globalsupport.com>



Indicator lamps on the headphones

The indicator lamp on each headphone indicates the product's status, as explained below.

Status		Indicator lamp display pattern	○ White
Pairing	Searching for devices	○ ○ ○ ○ ○ ○ ○ ○ ○ ...	Quickly flashing (○ : Gradually lights up)
	Waiting to be connected	○ ○ - - - ○ ○ - - - ...	Flashing
Connection	Connecting	○ - - - ○ - - - ○ - - ...	
Battery level	Battery level low	White in the pairing or connection status turns red.	

Voice guidance

The R (right) headphone plays English voice guidance in the following situations.

Situation	Voice guidance
Power is turned on	Power on
Power is turned off	Power off
Bluetooth is connected	Bluetooth connected
Bluetooth is disconnected	Bluetooth disconnected
Battery level is low	Low battery

Cleaning

Get into the habit of regularly cleaning the product to ensure that it will last for a long time. Do not use alcohol, paint thinners, or other solvents for cleaning purposes.

- Wipe any dirt off the headphones and charging case with a dry cloth.
 - Immediately wipe off any moisture (such as sweat) that has splashed onto the charging case battery jack, the charging terminals, and operation controls (such as buttons on the headphones). Failure to do so may result in a malfunction due to corrosion.
 - Natural oils from the skin are particularly likely to build up on the eartip attachment parts (see figure at right). If these areas are not cleaned, the eartips can become detached. Clean them regularly. Do not touch the areas where sound is produced as they are delicate. Doing so may result in malfunction.
 - If the USB charging cable is dirty, wipe the cable with a dry cloth immediately after use. Failure to clean the cable may cause it to deteriorate and harden over time, resulting in malfunction.
 - If the USB terminal of the charging cable is dirty, wipe it off with a dry cloth.
 - Clean the eartips by removing them from the headphones and manually cleaning them with a diluted mild detergent. After cleaning, wipe dry before using again.
- If the product will not be used for an extended period of time, store it in a well-ventilated place free from high temperatures and humidity.

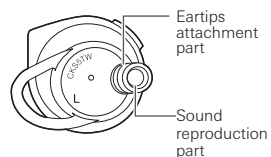

Eartips

Eartip size

The product includes silicone eartips in 4 sizes (XS, S, M, and L). At the time of purchase, the M-size silicone eartips are attached.

To ensure the best sound quality, select the eartip size that is best suited for you, and adjust the eartips inside your ears for a snug fit. It may be difficult to hear bass sounds if the eartips do not fit snugly in your ears.

Replacing the eartips

Remove the old eartip and attach the new eartip by pushing it onto the headphone at an angle (see figure).

Push firmly on the eartip so that the inside of the eartip expands, and push the eartip onto the post as far as it will go.

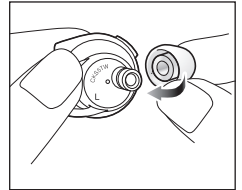

- Periodically remove and clean the eartips as they become dirty easily. Using dirty eartips may cause the headphones themselves to become dirty, resulting in deteriorated sound quality.
- Eartips are consumable parts that degrade through storage and use. If the eartips are loose and easily removed or if they appear to have degraded, purchase replacements.
- When reattaching eartips that were previously removed, be sure to check that they are securely attached. Injury or illness may occur if the eartips become detached and are left inside the ear.

Troubleshooting

Problem	Solution
Power is not supplied.	<ul style="list-style-type: none">• Charge the product.
Unable to pair.	<ul style="list-style-type: none">• Confirm that the Bluetooth device communicates using Ver. 2.1+EDR or higher.• Place the product and the Bluetooth device within 1 m (3.3') of each other.• Set the profiles for the Bluetooth device. For procedures on how to set profiles, refer to the Bluetooth device's user manual.• Remove the pairing information for the Bluetooth device then pair the product with this device again.• Place the headphones in the charging case and close the cover. Then, take the headphones out again.• When switching to a new Bluetooth device, you may not be able to pair because the previously connected Bluetooth device cannot be disconnected. In such cases, place the headphones into the charging case (with battery level remaining for the case) and press and hold (about 6 seconds) the multifunction button on the R (right) side. The indicator lamp lights in red. After lighting in red, the product will switch to the "searching for devices" state and you will be able to pair with your desired Bluetooth device.• While searching, this product may be displayed as "ATH-CKS5TW", "BLE_ATH-CKS5TW", or both on your Bluetooth device. If both are displayed, select "ATH-CKS5TW". If only one is displayed, select that one.
No sound is heard / Sound is faint.	<ul style="list-style-type: none">• Turn on the power of the product and the Bluetooth device.• Turn up the volume.• Make sure that this product and Bluetooth device are connected by the A2DP (or audio connection).• Disable pairing for this product and the Bluetooth device, then pair the product with this device again.• Move away from obstacles between the product and the Bluetooth device, such as people, metal or walls, and place the product and device closer together.• Switch the sound output of the Bluetooth device to this product.
L (left) and R (right) are not connected (sound does not come out from the L (left) side).	<ul style="list-style-type: none">• Check if there is no battery level remaining.• Place the headphones in the charging case and close the cover. Then, take the headphones out again.• If they are not connecting even after trying the above, the L (left) and R (right) may be disconnected. Use the following procedure to connect them manually.<ul style="list-style-type: none">- With the headphones and Bluetooth device disconnected, press the multifunction buttons on both L and R (left and right) three times. The indicator lamps on L and R (left and right) will change to pink, and after a while the indicator lamp on the L (left) side will slowly flash in white to indicate that the L (left) and R (right) are connected.

Troubleshooting

Problem	Solution
Sound is distorted / Noise is heard / Sound cuts out.	<ul style="list-style-type: none">• Turn down the volume.• Keep this product away from devices that emit radio waves such as microwaves and wireless routers.• Keep this product away from TVs, radios, and devices with built-in tuners. These devices can also be affected by the product.• Turn off the equalizer settings of the Bluetooth device.• Remove obstacles between the product and the Bluetooth device and place them closer together. For details, please refer to "For a more comfortable Bluetooth® communication experience" (p.5).• You may be able to improve the connection status by switching the connection codec to SBC. You can change it with our smartphone app. If you are using a connected device such as a smartphone or audio player that can change the connection codec, you may be able to set to SBC on that connected device. For details about the setting procedure, refer to the user manual of your connected device.
Cannot hear the voice of the caller / Voice of the caller is too quiet.	<ul style="list-style-type: none">• Turn on the power of the product and the Bluetooth device.• Turn up the volume.• Make sure that this product and Bluetooth device are connected by the HFP/ HSP (or call connection).• Disable pairing for this product and the Bluetooth device, then pair the product with this device again.• Switch the sound output of the Bluetooth device to this product.
The charging case cannot be charged.	<ul style="list-style-type: none">• Securely connect the included USB charging cable and charge the product.
Headphones cannot be charged.	<ul style="list-style-type: none">• Make sure that the product is placed in the charging case correctly.• Charge the charging case.• Wipe dirt off the charging terminal with a dry cloth.
The headphones come off my ears easily.	<ul style="list-style-type: none">• The 3D loop supports come attached to the headphones to provide better fit and stability. Use the included silicone rings as needed. Refer to "Attaching/ Removing the silicone rings" (p.12)

- For details about how to operate your Bluetooth device, refer to the device's user manual.
- If the problem still remains, reset the product. To reset the product, refer to "Reset function" (p.14) under "Using the product".

Specifications

Headphones

Type	Dynamic
Driver	10 mm
Sensitivity	110 dB/mW
Frequency response	5 to 40,000 Hz
Impedance	16 ohms

Microphone

Type	MEMS type
Polar pattern	Omnidirectional
Sensitivity	-40 dB (1 V/Pa, at 1 kHz)
Frequency response	50 to 4,000 Hz

Communication specifications

Communication system	Bluetooth version 5.0
Maximum RF output	10 mW EIRP
Maximum communication range	Line of sight - approx. 10 m (33')
Frequency band	2.402 GHz to 2.480 GHz
Modulation method	FHSS
Compatible Bluetooth profiles	A2DP, AVRCP, HFP, HSP
Support codec	Qualcomm® aptX™ audio, AAC, SBC
Supported content protection method	SCMS-T
Transmission band	20 to 20,000 Hz

Specifications

Other	
Power supply	Headphones: DC 3.7 V lithium ion battery/ Charging case: DC 3.7 V lithium polymer battery
Charging time	Headphones: Approx. 2 hours* / Charging case: Approx. 3.5 hours*
Operating time	Continuous transmission time (music playback): Max. approx. 15 hours* (headphones), Max. approx. 45 hours* (if charging case is used in combination)
Weight	Headphones: Approx. 8 g (0.28 oz) (L side), approx. 8 g (0.28 oz) (R side) / Charging case: Approx. 60 g (2.1 oz)
Water-resistant (drip-proof) performance	IPX2
Operating temperature	5°C to 40°C (41°F to 104°F)
Accessories	<ul style="list-style-type: none">• USB charging cable (30 cm (12"), USB Type-A / USB Type-C)• Eartips (XS, S, M, L)• Silicone rings
Sold separately	<ul style="list-style-type: none">• Eartips

* The above figures depend on operating conditions.

For product improvement, the product is subject to modification without notice.

- The Bluetooth® word mark and logos are owned by Bluetooth SIG, Inc. and any use of such marks by Audio-Technica Corporation is under license. All other trademarks are property of their respective owners.
- Apple and the Apple logo are trademarks of Apple Inc. registered in the United States and other countries.
- The App Store is a service mark of Apple Inc.
- Google Play and the Google Play logo are trademarks of Google LLC.
- USB Type-C™ is a trademark of USB Implementers Forum.
- Qualcomm aptX is a product of Qualcomm Technologies, Inc. and/or its subsidiaries.
Qualcomm is a trademark of Qualcomm Incorporated, registered in the United States and other countries, used with permission. aptX is a trademark of Qualcomm Technologies International, Ltd., registered in the United States and other countries, used with permission.

